



Specification For Approval

Customer: _____

Battery model name: GEB 855085

Customer model number: _____

Revision: _____

Date: _____

Customer approval

Comment:

Customer's signature/ Date : _____

Prepared	Checked	Approved



Content

1. Scope	3
2. Model: GEB855085	3
3. Dimensions of battery pack	3
4. Battery configuration	4
5. Specification of cell	5
6. Battery Cell Performance Criteria	6
7. PCM parameter	8
8. Packing Storage and Transportation	9
9. Use Attentions	10

1.Scope

This document describes the Product Specification of the Lithium-Polymer (LIP) rechargeable battery cell supplied by General Electronics Battery Co., Ltd.

Model: GEB 855085

GEB855085

PCB

3.Dimensions of battery pack

T:≤8.7mm * W:≤50.3mm * L:≤87mm

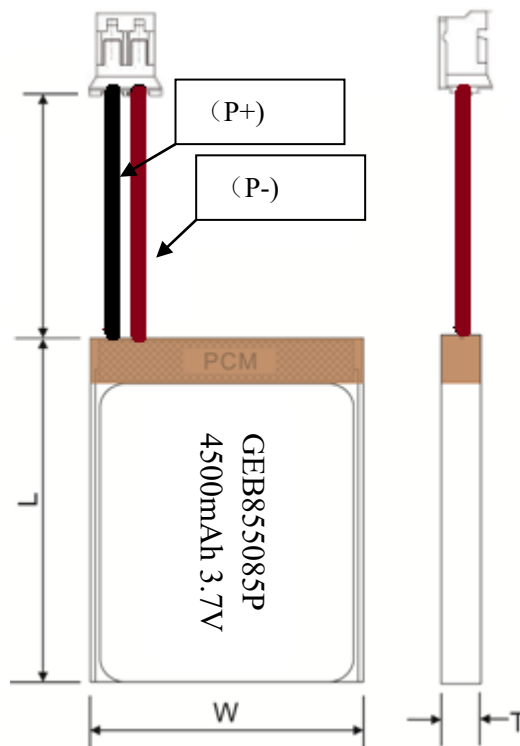

- Connecting Wires
- Red: connect to “+”
- Black : connect to “ - ”

4. Battery configuration

4. 1 Battery portfolio primarily BOM



No.	Item	criteria	Remarks
1	Semi-manufactured cell	803450	
2	PCB	DW01+8205*2	
3	Wire/connector	UL1007-AWG22, JST-XHR-2.54 reverse	

4. 2 Specifications of battery pack

No.	Item	Specifications	Comments
1	Assemble model	Simple link	
2	Nominal Capacity	4500mAh	
3	Rated Impedance	$\leq 180\text{m}\Omega$ (Added after the board) at 25 °C	
4	Battery Weight	Approx: 90g	
5	Overcharge protection voltage	4.30±0.05V	
6	Max. charge current	1 C	
7	Over discharge protection voltage	2.5v	
8	Max discharge current	1C	
9	Charge temperature	0°C ~ +45°C	
10	Discharge temperature	-10°C ~ +55°C	
11	Storage temperature	less than 1 month	-10~+55°C
		less than 3 month	-10~+40°C
		less than 1 year	0~+25°C
6	Storage humidity	$\leq 75\%$	



5. Specifications of cell

No.	Items	Specifications	
1	Charge voltage	4.2V	
2	Nominal voltage	3.7V	
3	Nominal capacity	4500mAh 0.2 C Discharge	
4	Charge current	Standard Charging: 0.2 C Rapid charge: 1.0 C	
5	Standard Charge	Charging the cell initially with constant current at 0.2 C and then with constant voltage at 4.2V till charge current declines to 0.02 C	
6	Charging time	Standard Charging: 6.0 hours (Ref.) Rapid charge: 1.5-2.5 hours (Ref.)	
7	Max. charge current	1.0 C	
8	Max. discharge current	1.0 C	
9	Discharge cut-off voltage	2.75V	
	Charge temperature	0°C ~ +45°C	
10	Discharge temperature	-10 ~ +55°C	
11	Temperature range for storage	less than 1 month	-10~+55°C
		less than 3 months	-10~+40°C
		less than 1 year	0~+25°C
6	Cell Weight	Approx: 85g	
13	Cell Dimension	Length: 85.5 mm Max Width: 50.3mm Max Thickness: 8.0mm Max	



6. Battery Cell Performance Criteria

6.1 Electrical characteristics

No.	Items	Test Method and Condition	Criteria
6.1.1	Standard Charge	Charging the cell initially with constant current at 0.2 C and then with constant voltage at 4.2V till charge current declines to 0.02 C	
6.1.2	First Discharge Capacity	The capacity means the first discharge capacity of the cell, which is measured with discharge current of 0.5 C with 3.0V cut-off after standard charge.	≥4500mAh
6.1.3	Cycle Life	Test condition: Charge: 0.2 C to 4.2V Discharge: 0.2 C to 3.0V 80% or more of 1 st cycle capacity at 0.2C discharge of Operation	≥500 (laps)
6.1.4	Self-discharge	After the standard charging, stored the cells under the condition 25.0±5.0°C (Temperature) ≤75.0%RH (Humidity) for 28 days, then measured the capacity with 0.2 C till 3.0V with previous standard discharge capacity of the ratio	Residual capacity >90%
6.1.5	Initial impedance of cell	Internal resistance measured at AC 1KHz after 50% charge , at 25°C.	≤180mΩ
6.1.6	Temperature Characteristics	1. According to item 6.1.1, at 25±5°C. 2. Capacity comparison at each temperature, measured with constant discharge current 0.2 C with 3.0V cut-off. Percentage as an index of the capacity compared with 100% at 25°C	-10°C: ≥50% 25°C: 100% 60°C: ≥85%
6.1.7	Constant humidity and temperature	After standard charging, laying the battery 48h at 40±2°C, RH 93±2%. Recording 1C discharging time	No distortion No electrolytes leakage



6.2 Mechanical characteristics

No.	Items	Test Method and Condition	Criteria
1	Vibration Test	After standard charging, fixed the cell to vibration table and subjected to vibration cycling that the frequency is to be varied at the rate of 1Hz per minute between 10Hz and 55Hz, the excursion of the vibration is 1.6mm.The cell shall be vibrated for 30 minutes per axis of XYZ axes.	No leakage No fire
2	Drop Test	The cell is to be dropped from a height of meter twice onto concrete ground.	No fire, no leakage.

6.3 Visual inspection

There shall be no such defect as scratch, flaw, crack, and leakage, which may adversely affect commercial value of the cell.

6.4 Standard environmental test condition

Unless otherwise specified, all tests stated in this Product Specification are conducted at below condition:

Temperature: $25.0 \pm 5.0^{\circ}\text{C}$

Humidity: $\leq 75.0\% \text{RH}$

7. PCM parameter PCM

7.1 PCM

Item	Symbol	Content	Criteria
Over charge Protection	V_{DET1}	Over charge detection voltage	$4.3V \pm 0.05V$
Over discharge	V_{DET2}	Over discharge detection voltage	$2.4V \pm 0.1V$
Over Current	I_{DP}	Over current detection current	$6.5 \pm 1.5A$
Interior resistance	R_{DS}	Main loop electrify resistance (Battery Vol=3.9V)	B- to P- B-至 P- $R_{DS} \leq 60m\Omega$
Current consumption	I_{DD}	Current consume in normal operation	MIN: $0.3 \mu A$ MAX: $8.0 \mu A$

7.2 Application Schematic

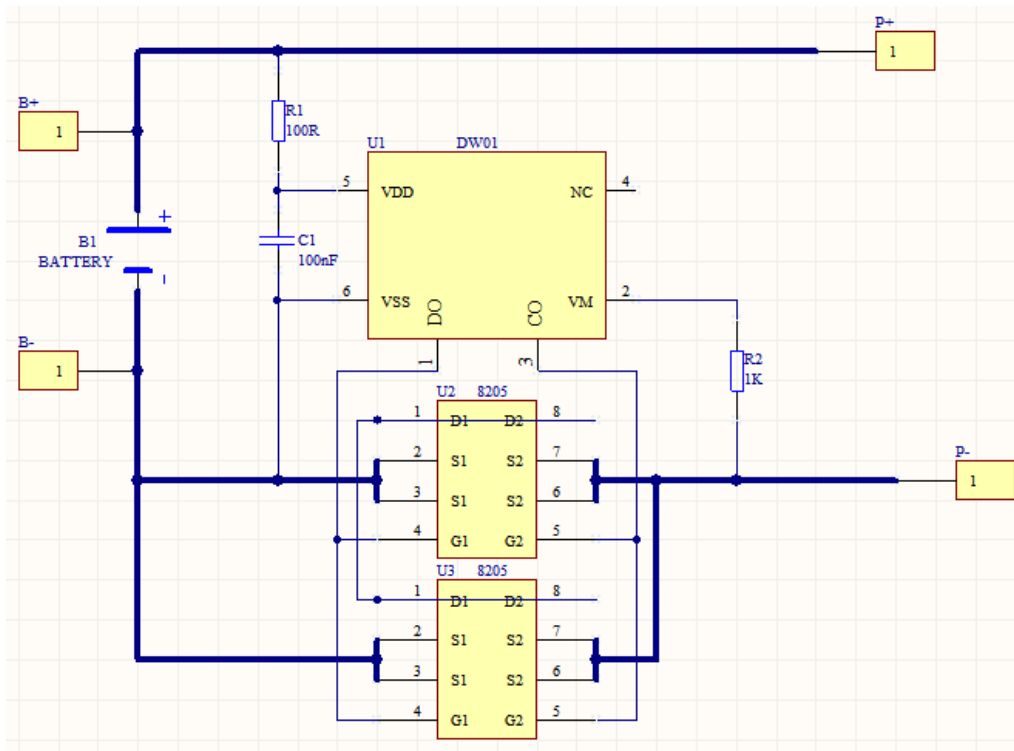

8. Packaging、 Storage and Transportation

8.1 Packaging model

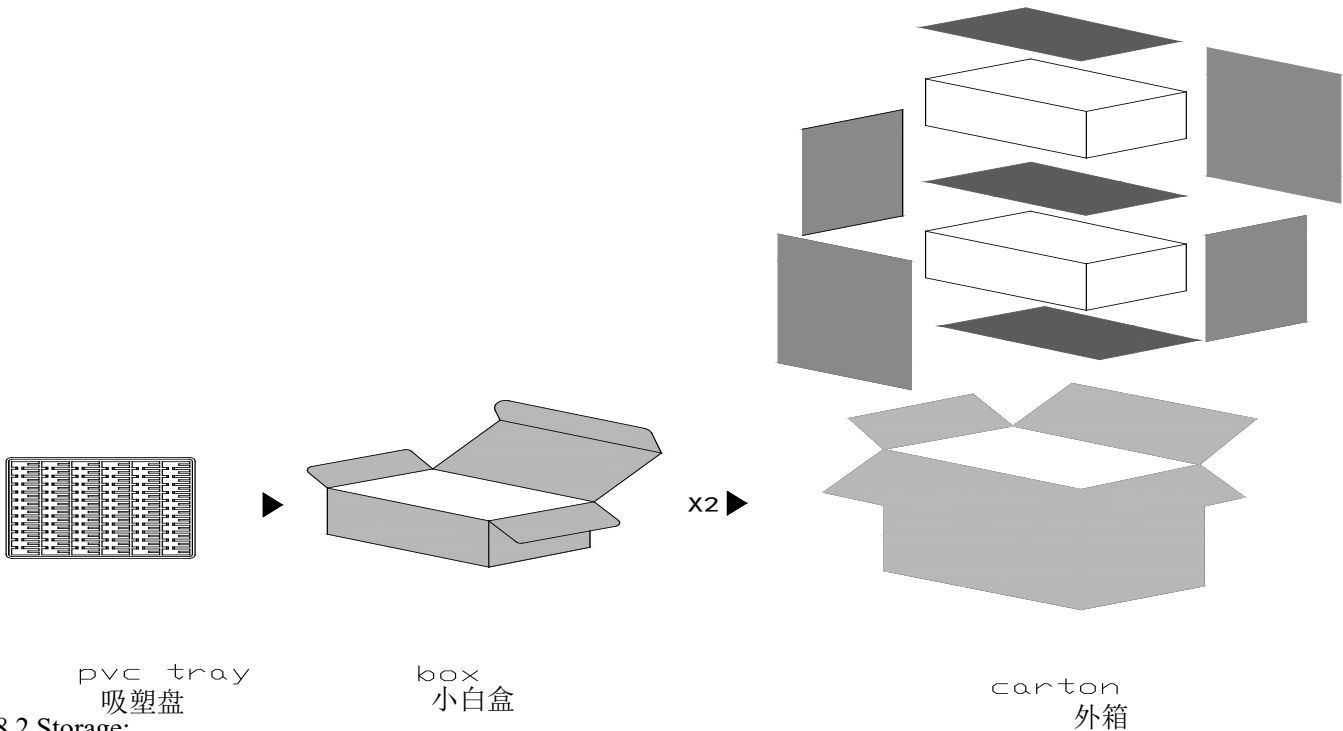

8.2 Storage:

- 8.2.1 The Li-ion battery pack should be stored in a cool, dry and well-ventilated area, and should be far from the fire and the high temperature.
- 8.2.2 The battery should store in the product specification book stipulation temperature range, the best storage temp. is $25\pm 5^{\circ}\text{C}$. The best humidity is $60\pm 15\%$.
- 8.2.3 The battery should be stored within room temperature, and charged to 40%~60% electric quantity (3.85V) . In order to avoid over-discharge, we suggest charge and discharge the batteries every three months., Then charge to 40%~60%electric quantity (3.85V).

8.3 Transportation:

- 8.3.1 Do not mix the battery products with other cargos.
- 8.3.2 Do not immerse the battery products in water or allow it to get wet.
- 8.3.3 Do not over 7 layers staking and upside-down.
- 8.3.4 The highest temperature in transportation is lower than 65°C .

9. Use Attentions:

To ensure proper use of the battery please read the manual carefully before using it.

9.1 Warnings:

- 9.1.1 Do not expose to, dispose of the battery in fire.
- 9.1.2 Do not put the battery in a charger or equipment with wrong terminals connected.
- 9.1.3 Avoid shorting the battery.
- 9.1.4 Avoid excessive physical shock or vibration.
- 9.1.5 Do not disassemble or deform the battery.
- 9.1.6 Do not immerse in water.
- 9.1.7 Do not use the battery mixed with other different type or model batteries.
- 9.1.8 Keep out of the reach of children.

9.2 Charge:

- 9.2.1 Battery must be charged in appropriate charger only.



9.2.2 Never use a modified or damaged charger.

9.2.3 Do not leave battery in charger over 24 hours.

9.2.4 Charging current: Can not surpass the biggest charging current which in this specification book stipulated.

9.2.5 Charging voltage: Does not have to surpass the highest amount which in this specification book stipulated to decide the voltage.

9.2.6 Charge temperature: The battery must carry on the charge in the ambient temperature scope which this specification book stipulated.

9.2.7 Uses constant current and constant voltage way charge. Pls connect the positive and negative terminals in right way, or the battery may be damaged.

9.3 Discharge:

9.3.1 The discharging current should not surpass the biggest discharging current this specification book stipulation, The large discharge current can cause heat and lower capacity.

9.3.2 Discharge temperature: The battery discharge must carry on in the ambient temperature scope which this specification book stipulated.

9.3.3 Over-discharge: After short time over discharge, then charge immediately won't damage the battery. But the battery will be damaged for being long time over discharged. During long-term storage, the battery may be within over-discharging condition for self discharge. To prevent the occurrence of over discharging, the battery should maintain the certain capacity when storage.

9.4 Handling of Cells

1 Soft Al foil

- Don't strike battery with any sharp edge parts
- Trim your nail or wear glove before taking battery
- Clean worktable to make sure no any sharp particle

2 Sealed edge may be damaged by heat above 100°C, bend or fold sealed edge.

3 Handling of Tabs

The battery tabs are not so stubborn especially for aluminous tab.

Do not bend tabs unnecessarily.

4 Tab Connection

Ultrasonic welding or spot welding is recommended for LIP tab connection method.

Battery pack should be designed that shear force are not applied to the LIP tabs.

If apply manual solder method to connect tab with PCM, below notice is very important to ensure battery performance:

- The solder iron should be temperature controlled and ESD safe;
- Soldering temperature should not exceed 370°C;
- Soldering time should not be longer than 3s;
- Soldering times should not exceed 5 times, Keep battery tab cold down before next time soldering;
- Directly heat cell body is strictly prohibited; Battery may be damaged by heat above approx. 100°C

9.5 Disposal

Regulations vary for different countries. Dispose of in accordance with local regulations.

9.6 Note:

Any other items which are not covered in this specification shall be agreed by both parties.